

Varenummer: 0109087  
 Beskrivelse: Seeger låsering AS 80X4.0  
 Fjederstål  
 Note: Monteres med ZGA tang

## Mål

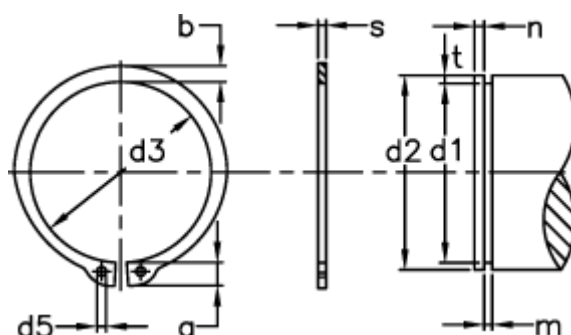

a max	= 9.8	d5 min	= 3.0	s	= 4.00
AN mm <sup>2</sup>	= 430.0	FN kN	= 71.60	t	= 1.75
B	= 2.56	FRg kN	= 50.0	Tang	= ZGA-3
b	= 7.4	FR kN	= 328.0	tol	= -0.10
Betegnelse	= AS 80	g	= 3.0	tol	= +0,46 -1,10
d1	= 76.5	m min	= 4.15	tol	= -0.30
d2	= 80	n abl x 1000	= 6	vægt kg/1000	= 42.40
d3	= 74.5	Nominel træk	= 5.3		